

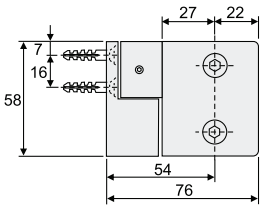

KERAGLASS

M-981R-WG90



-  polished chrome
-  satin chrome
-  satin nickel

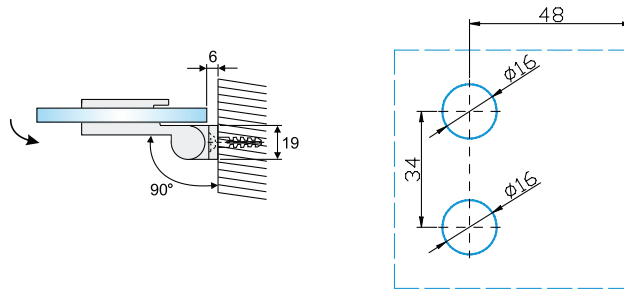
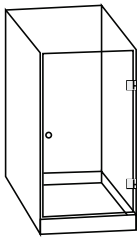



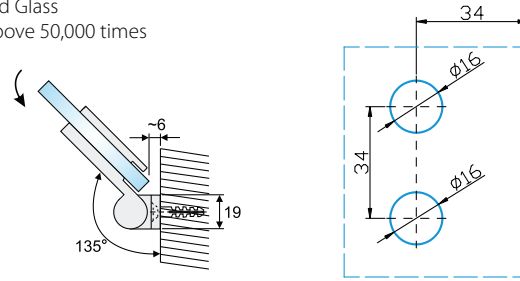

- **90 deg. Right Shower Hinge:** for glass door from 8 to 10 mm thick and 800 mm wide.
The door will be closed automatically when being closed to about 25 deg.
- **Weight of door:** 40 kg
- **Remark:** Hardened Glass
- **Times fatigue:** Above 50,000 times

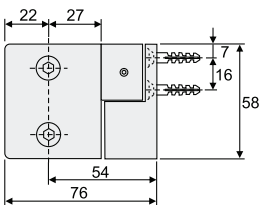

The angle of 135 deg. can be done by turning the hinge's sleeve.

M-981L-WG90



-  polished chrome
-  satin chrome
-  satin nickel

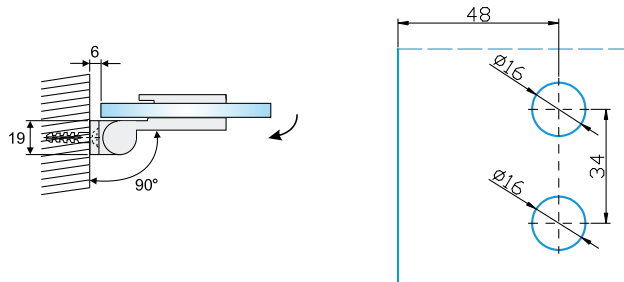
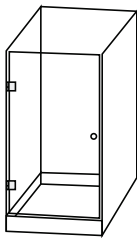

- **90 deg. Shower Hinge:** for glass door from 8 to 10 mm thick and 800 mm wide.
The door will be closed automatically when being closed to about 25 deg.
- **Weight of door:** 40 kg
- **Remark:** Hardened Glass
- **Times fatigue:** Above 50,000 times

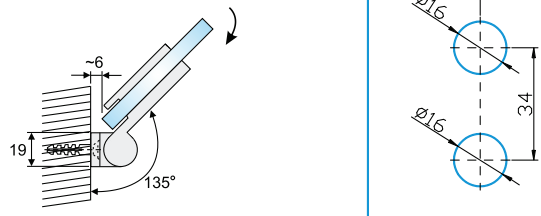

The angle of 135 degrees can be done by turning the hinge's sleeve.



KERAGLASS

M-981R-180

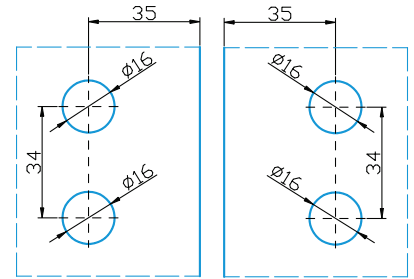
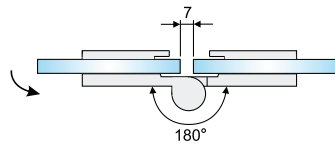
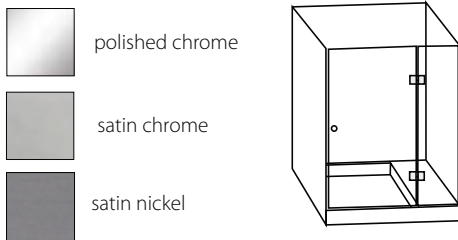
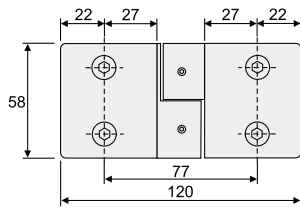

- **180 deg. Right Shower Hinge:** for glass door from 8 to 10 mm thick and 800 mm wide.
The door will be closed automatically when being closed to about 25 deg.
- **Remark:** Hardened Glass
- **Times fatigue:** Above 50,000 times

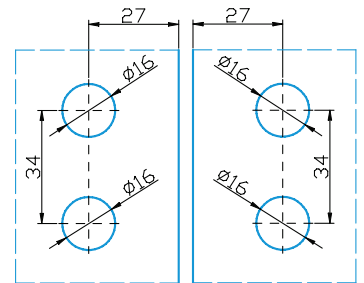
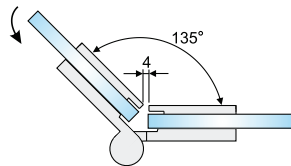

The angle of 135 degrees can be done by turning the hinge's sleeve.

M-981L-180

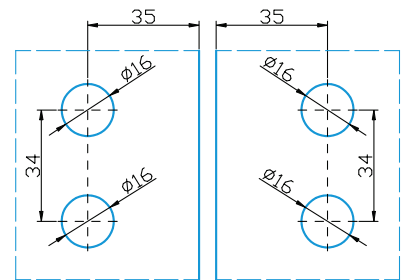
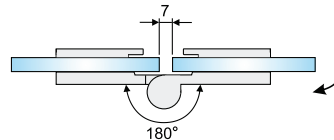
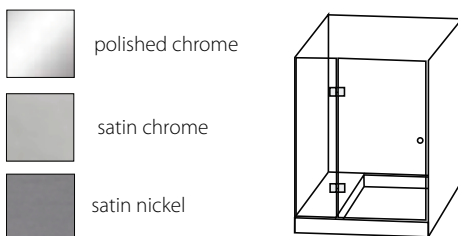
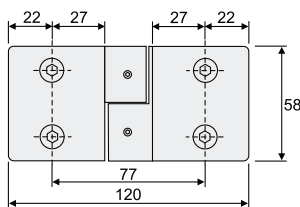

- **180 deg. Left Shower Hinge:** for glass door from 8 to 10 mm thick and 800 mm wide.
The door will be closed automatically when being closed to about 25 deg.
- **Weight of door:** 40 kg
- **Remark:** Hardened Glass
- **Times fatigue:** Above 50,000 times

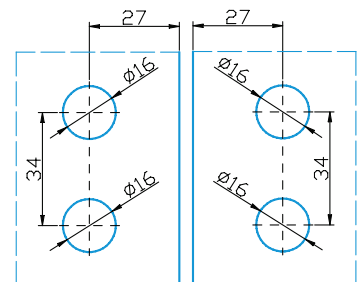
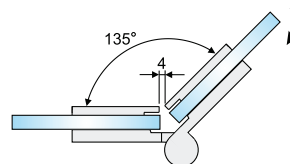

The angle of 135 degrees can be done by turning the hinge's sleeve.



KERAGLASS

M-933U



-  polished chrome
-  satin chrome
-  satin nickel

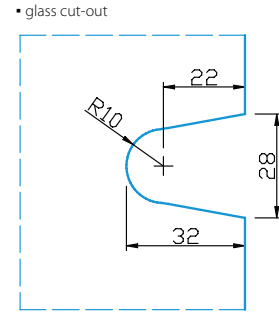
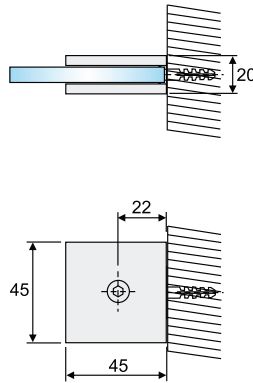

Suitable for glass wall from 8 to 10 mm

M-981BK-WG90



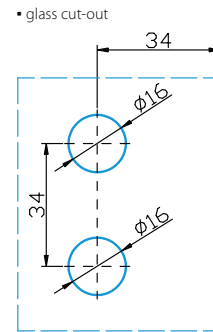
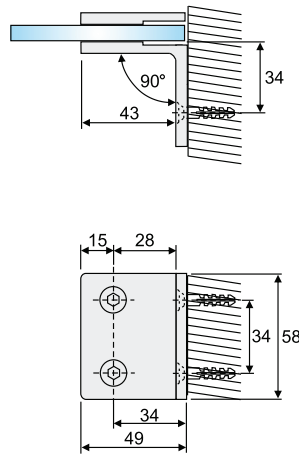

-  polished chrome
-  satin chrome
-  satin nickel



Suitable for glass wall from 8 to 10 mm

M-981BK-90



-  polished chrome
-  satin chrome
-  satin nickel

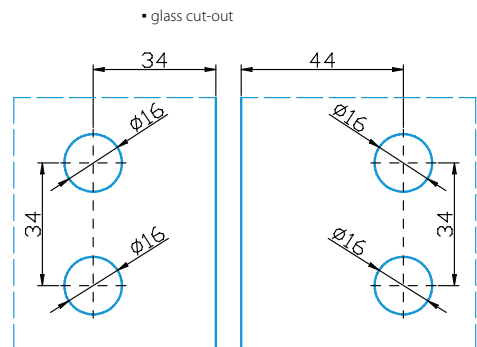
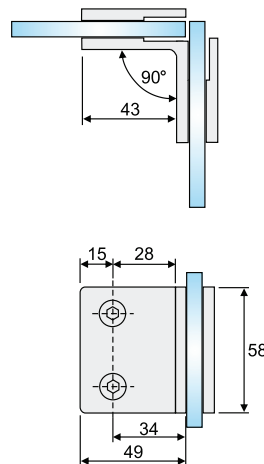

Suitable for glass wall from 8 to 10 mm



KERAGLASS

M-921-105-N



-  polished chrome
-  satin chrome
-  satin nickel

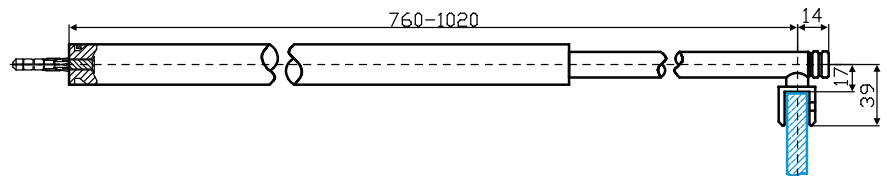
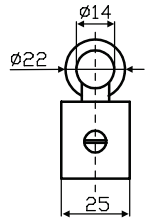
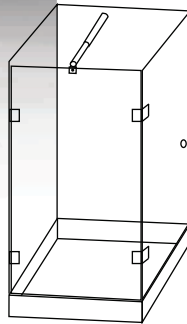

M-921-125-N

-  polished chrome
-  satin chrome
-  satin nickel

Glass to wall stability connectors for 8-10 mm glass

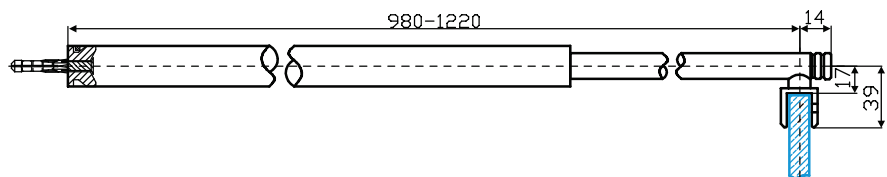
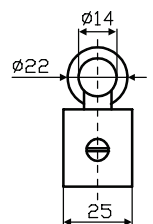

M-9765



-  polished chrome
-  satin chrome
-  satin nickel

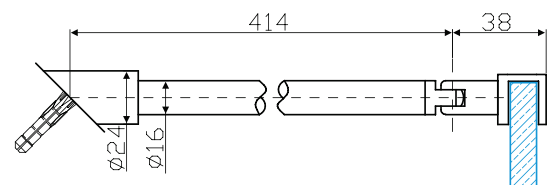
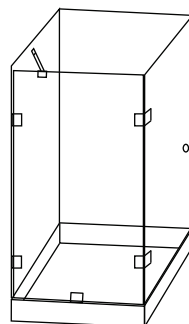

Glass to wall stability connector for 8-10 mm glass