

Telescopico Sincro 2 vie V-2200

Telescopico Sincro 2 vie + fisso V-2250

2-way Telescopic Sincro - 2-way Telescopic Sincro + fixed

2 läufige Teleskop-Schiebetür Sincro - 2 läufige Teleskop-Schiebetür Sincro mit Festverglasung



Nuova serie "SINCRO"

Piacevole da usare

Grande evoluzione dei nuovi scorrevoli telescopici che, tramite la combinazione di una cinghia dentata ed appositi congegni permette, con un minimo sforzo, un facile, leggero e silenzioso movimento sincronizzato.

New "SINCRO" series Comfortable use

Einfache Handhabung A great evolution for the new sliding Telescopic that, thanks to the combination of a toothed belt with the appropriate devices, allow an easy, light and silent synchronized movement with the least possible effort.

Neue Serie "SINCRO" Einfache Handhabung

Großartige Entwicklung mit den neuen Teleskop-Schiebetüren, die durch Kombination mit Zahnriemen und angepassten Halterungen, eine einfache, leichte und lautlose synchronisierte Bewegung ermöglichen.



Telescopici V-4000 / V-4100 / V-4200

Sistema scorrevole Telescopico con guida di scorrimento per due ante mobili con movimento a trascinamento più un'anta fissa, tutto nello stesso profilo d'alluminio, di semplice montaggio a parete o soffitto.

Carrelli ad elevata scorrevolezza e meccanismo di regolazione per la messa in bolla dell'anta.

Telescopical sliding door system with track for two sliding doors with follower mechanism and one fixed panel, all in one profiled aluminium track. Simple fixing on wall or under the ceiling.

Clamp carriers light running with adjustable Mechanic for Door levels on the track without removing the glass panels.

Teleskopisches Schiebetürsystem mit Laufschiene für zwei verschiebbare Glaselemente mit Mitnehmer und einem festem Seitenteil, alles in einem Laufschieneprofil aus Aluminium, für Wand oder Deckenbefestigung. Das System inkludiert den Klemmlaufwagen, leichtlaufend durch eine spezielle Rollentechnik und einen verstellbaren Mechanismus für eine waagrechte Halterung. Auch nach der Glasmontage ist eine Höhenregulierung von 10mm möglich.



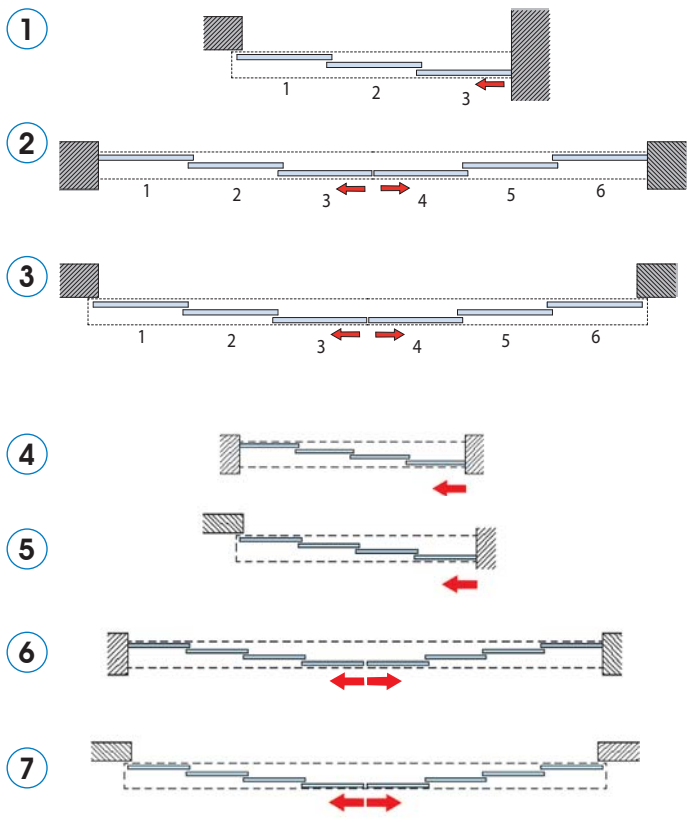

V-4200

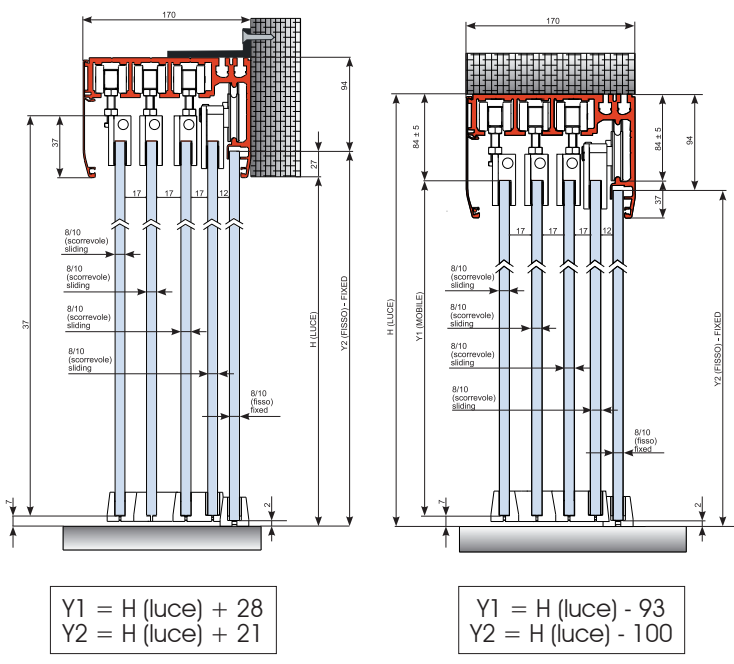

V-4000

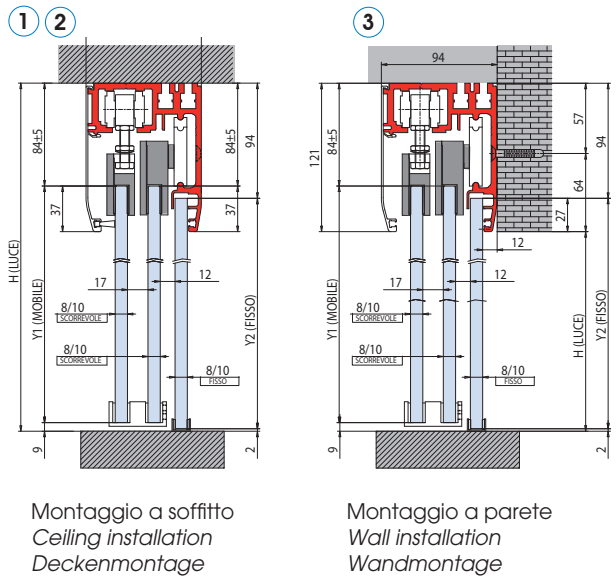

V-4100

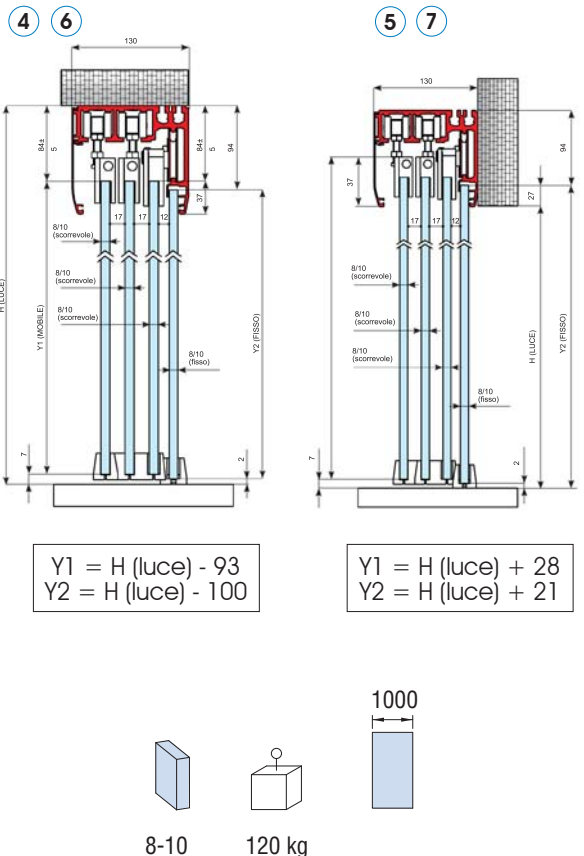

AN = Alluminio anodizzato
Aluminium anodized
Aluminium Silberfarbig

Easy 3 vie telescopico V-1300 Easy 4 vie telescopico V-1400





V-1300

Montaggio a soffitto o a parete
Ceiling or wall installation
Decken- bzw. Wandmontage

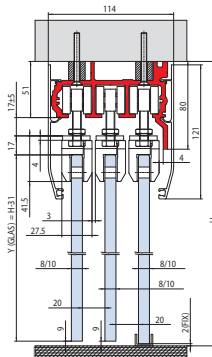
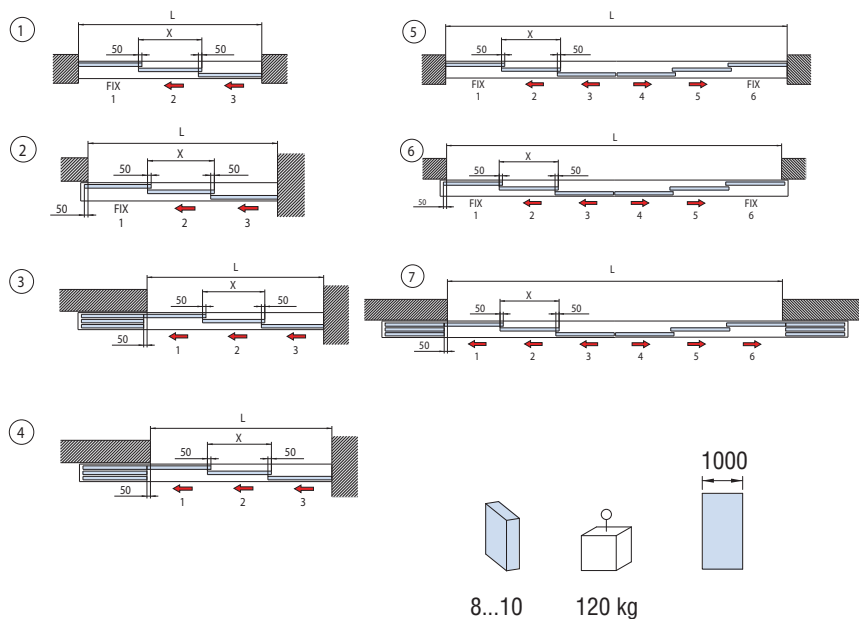

$Y = H - 94$

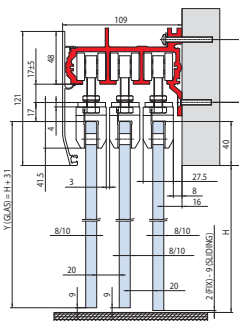

$Y = H + 31$

V-1400

Montaggio a soffitto o a parete
Ceiling or wall installation
Decken- bzw. Wandmontage

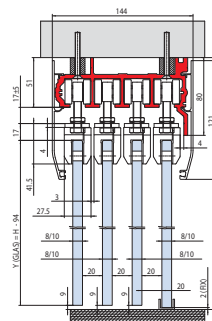
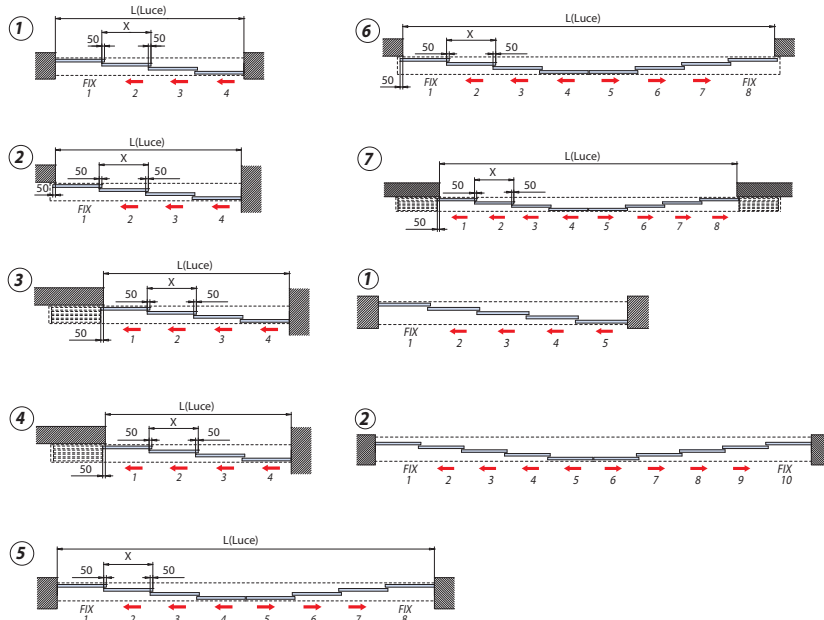

$Y = H - 94$

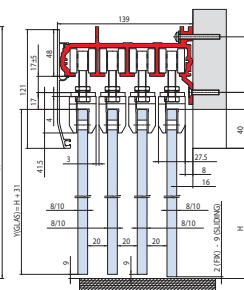

$Y = H + 31$

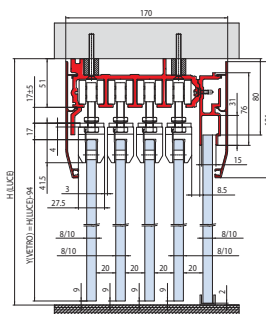

V-1400

con V-1104
Montaggio
a soffitto
with V-1104
Ceiling installation
mit V-1104
Decken-Montage

$Y = H - 94$
 $Y2 \text{ fisso} = H - 82$

AN = Alluminio anodizzato
Aluminium anodized
Aluminium Silberfarbig

Telescopico Sincro 2 vie V-2200

Telescopico Sincro 2 vie + fisso V-2250

2-way Telescopic Sincro - 2-way Telescopic Sincro + fixed

2 läufige Teleskop-Schiebetür Sincro - 2 läufige Teleskop-Schiebetür Sincro mit Festverglasung



Nuova serie "SINCRO"

Piacevole da usare

Grande evoluzione dei nuovi scorrevoli telescopici che, tramite la combinazione di una cinghia dentata ed appositi congegni permette, con un minimo sforzo, un facile, leggero e silenzioso movimento sincronizzato.

New "SINCRO" series Comfortable use

Einfache Handhabung A great evolution for the new sliding Telescopic that, thanks to the combination of a toothed belt with the appropriate devices, allow an easy, light and silent synchronized movement with the least possible effort.

Neue Serie "SINCRO" Einfache Handhabung

Großartige Entwicklung mit den neuen Teleskop-Schiebetüren, die durch Kombination mit Zahnriemen und angepassten Halterungen, eine einfache, leichte und lautlose synchronisierte Bewegung ermöglichen.



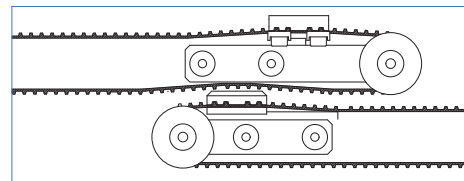
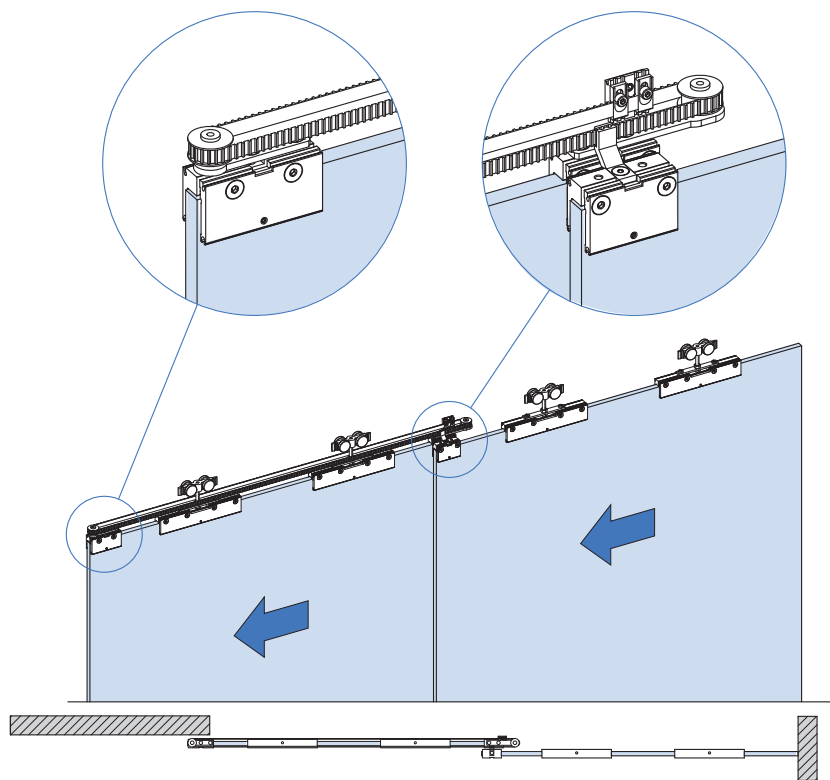

Regolazione altezza ± 4 mm
Height adjustment ± 4 mm
Höheneinstellung ± 4 mm

8...13.5 100 kg

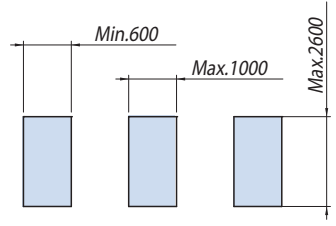

Nessun taglio vetro
No glass preparation
Keine Glasbearbeitung

V-2200 Set 2

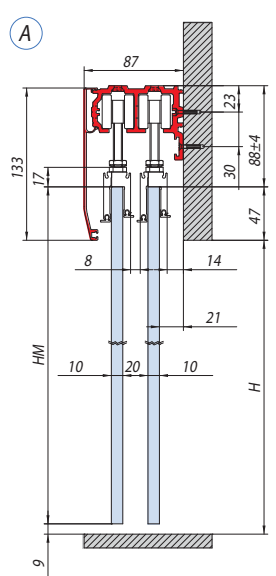

$HM = H + 38$

V-2200 Set 1

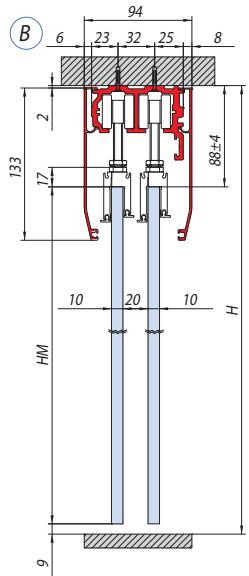

$HM = H - 97$

V-2250 Set 2

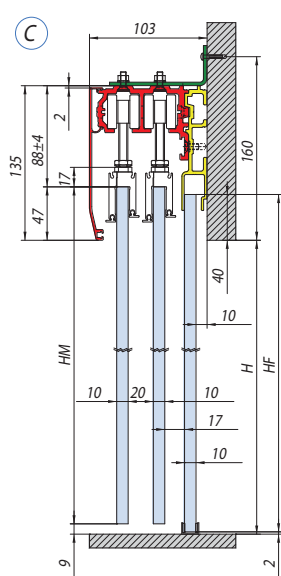

$HM = H + 38$
 $HF = H + 38$

V-2250 Set 1

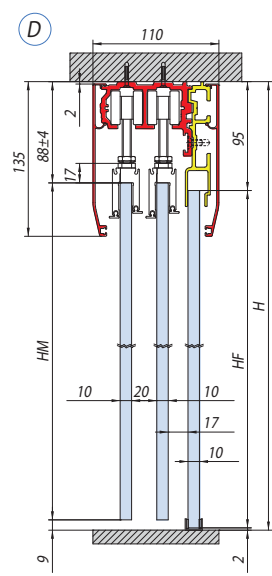

$HM = H - 97$
 $HF = H - 97$

AN = Alluminio anodizzato
Aluminium anodized
Aluminium Silberfarbig

Effetto inox
Inox effect
Inox effekt

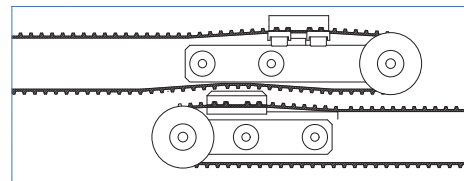
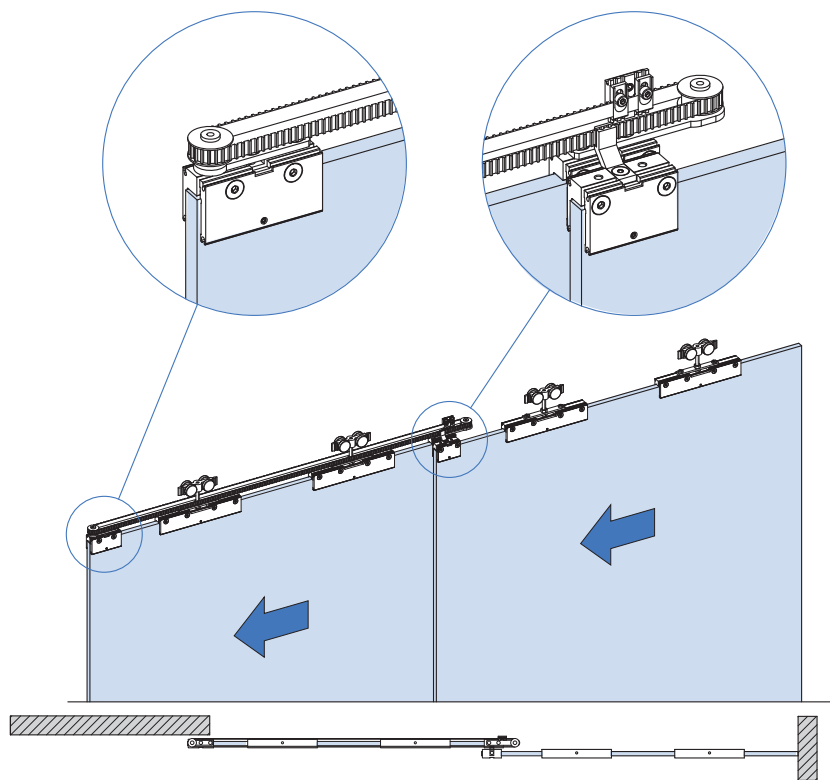

Regolazione altezza ± 4 mm
Height adjustment ± 4 mm
Höheneinstellung ± 4 mm

8...13.5 100 kg

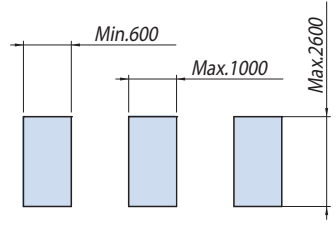

Nessun taglio vetro
No glass preparation
Keine Glasbearbeitung

V-2200 Set 2

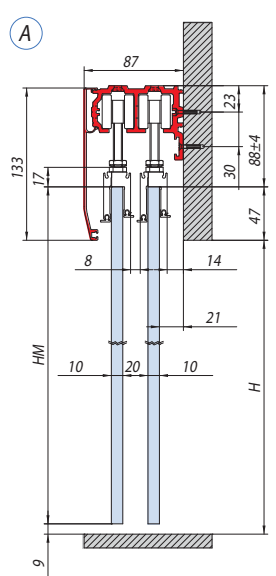

$HM = H + 38$

V-2200 Set 1

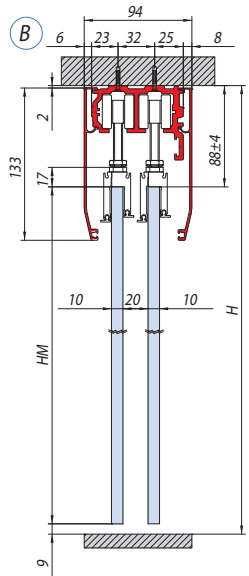

$HM = H - 97$

V-2250 Set 2

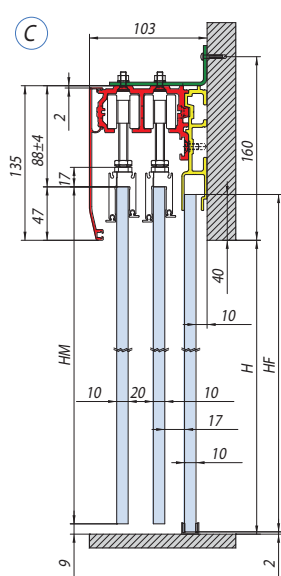

$HM = H + 38$
 $HF = H + 38$

V-2250 Set 1

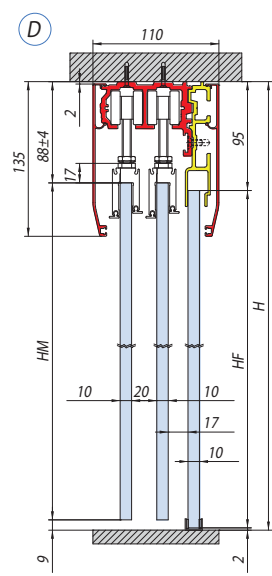

$HM = H - 97$
 $HF = H - 97$

AN = Alluminio anodizzato
Aluminium anodized
Aluminium Silberfarbig

Effetto inox
Inox effect
Inox effekt